

PZ 72E User Manual

E-610.C0 LVPZT Controller

Release: 6.2.0 Date: 2018-09-18



This document describes the following product(s)*:

- E-610.C0
LVPZT Controller (OEM) for Capacitive Sensors

*Strain gauge and LVDT sensor E-610 versions are described in a separate manual, PZ 70E.

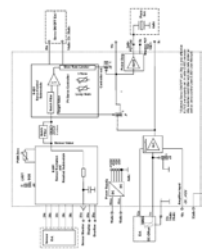

Physik Instrumente (PI) GmbH & Co. KG is the owner of the following trademarks: PI[®], PICMA[®], PILine[®], PiezoWalk[®], NEXACT[®], NEXLINE[®], NanoCube[®], Picoactuator[®], Plnano[®], PIMag[®], Q-Motion[®]

The following designations are protected company names or registered trademarks of third parties: Linux, NI LabVIEW, MATLAB, National Instruments, Microsoft[®] and Windows[®] are either registered trademarks or trademarks of Microsoft Corporation in the United States and / or other countries.

Copyright 1999–2018 by Physik Instrumente (PI) GmbH & Co. KG, Karlsruhe, Germany.
The text, photographs and drawings in this manual enjoy copyright protection. With regard thereto, Physik Instrumente (PI) GmbH & Co. KG reserves all rights. Use of said text, photographs and drawings is permitted only in part and only upon citation of the source.

First printing 2018-09-18
Document Number PZ 72E BRo, ASt, Release 6.2.0
E-610C0_User_PZ72E610.doc

Subject to change without notice. This manual is superseded by any new release. The newest release is available for download at www.pi.ws.

About this Document

Users of this Manual

This manual is designed to help the reader to install and operate the E-610.C0 LVPZT Controller with capacitive sensor processing. It assumes that the reader has a fundamental understanding of basic servo systems, as well as motion control concepts, piezoelectric drives and applicable safety procedures.

The manual describes the physical specifications and dimensions of the E-610.C0 LVPZT Controller as well as the installation procedures which are required to put the associated motion system into operation.

This document is available as PDF file. Updated releases are available via FTP or email: contact your Physik Instrumente sales engineer or write to info@pi.ws.

Conventions

The notes and symbols used in this manual have the following meanings:

DANGER

Indicates the presence of high voltage (> 50 V). Calls attention to a procedure, practice or condition which, if not correctly performed or adhered to, could result in injury or death.



CAUTION

Calls attention to a procedure, practice, or condition which, if not correctly performed or adhered to, could result in damage to equipment.



NOTE

Provides additional information or application hints.

Related Documents

The E-802 Servo-Control Submodule which comes with the E-610.C0 LVPZT Controller is described in its own manual. Updated releases are available via FTP or email: contact your Physik Instrumente sales engineer or write to info@pi.ws.

E-802 User Manual, PZ150E

The E-610 versions with LVDT and strain gauge sensor processing as well as the E-610 amplifier-only version are described in a separate manual (PZ 70E).

Contents

1	Introduction	3
1.1	Prescribed Use	3
1.2	General Description	4
1.2.1	Servo-Control	4
1.2.2	Applications	4
1.2.3	Computer Control	5
1.3	Safety Precautions	5
2	Description	7
2.1	Main Module	7
2.2	Included Connector	7
3	Operating Modes	8
3.1	Manual Offset Operation	8
3.2	External Operation	8
3.3	External Operation with DC Offset	8
3.4	Open-Loop (Voltage-Controlled) Operation	9
3.5	Closed-Loop (Position-Controlled) Operation	9
4	Installation and Operation	11
4.1	General Instructions	11
4.2	System Setup	12
4.3	User Electronics and Sensor Monitor Signal	13
5	E-610 Calibration	14
5.1	Equipment Needed for Calibration	14
5.2	Preparations	15
5.3	Mechanical Zero-Point Adjustment	15
5.4	Electrical Zero-Point Calibration	15
5.5	Second-Order Polynomial Linearization	16
5.6	Static Gain Adjustment	17
5.7	Dynamic Calibration	18
6	Electronics	19
6.1	Block Diagram	20
6.2	Front Panel Indicators	21

Contents

6.3	Adjustment Elements and Connectors	21
6.3.1	Main Board and E-802.55 Submodule.....	21
6.3.2	PZT Amplifier Section Jumpers.....	23
6.4	Servo-Control Electronics	24
7	Technical Data	25
7.1	Specifications.....	25
7.2	Frequency Response	26
7.3	Dimensions	26
8	Pin Assignments	27
8.1	System Connection Summary.....	27
8.2	32-Pin Main Connector	28
8.3	Sensor Connectors	28
9	Appendix: Piezoelectric Positioning Topics	29
9.1	Low-Voltage Piezoelectric Translators (LVPZT).....	29
9.2	Sensors for Low-Voltage PZT Translators.....	29
10	EC Declaration of Conformity	31

1 Introduction

1.1 Prescribed Use

Based on their design and realization, the E-610.C0 LVPZT Controllers are intended to drive capacitive loads, in the present case, piezoceramic actuators. The E-610.C0 must not be used for applications other than stated in this manual, especially not for driving ohmic (resistive) or inductive loads. E-610.C0s can be operated in closed-loop mode using capacitive position sensors. Appropriate sensors are provided by PI and integrated in the mechanics according to the mechanics product specifications. Other sensors may be used as position sensors only with permission of PI.

Observe the safety precautions given in this User Manual.

E-610.C0s conform to Measurement Category I (CAT I) and may not be used for Measurement Categories II, III or IV. Other use of the device (i.e. operation other than instructed in this Manual) may affect the safeguards provided.

E-610.C0s meet the following minimum specifications for operation*:

- Indoor use only
- Altitude up to 2000 m
- Ambient temperature from 5°C to 40°C
- Relative humidity up to 80% for temperatures up to 31°C, decreasing linearly to 50% relative humidity at 40°C
- Line voltage fluctuations of up to $\pm 10\%$ of the line voltage
- Transient overvoltages as typical for public power supply
Note: The nominal level of the transient overvoltage is the standing surge voltage according to the overvoltage category II (IEC 60364-4-443).
- Degree of pollution: 2

E-610.C0 amplifier/controller modules are designed to drive and to control low-voltage piezoelectric translators (LVPZTs) with capacitive sensor position feedback. E-610 modules for use

* Any more stringent specifications in the Technical Data table are, of course, also met.

with SGS or LVDT sensors are described in a separate manual.

1.2 General Description

The E-610.C0 is a single-channel amplifier and position controller with an average output power of 6 watts. The design is based on a controllable DC/DC converter, optimized for driving capacitive loads.

The E-610.C0 can be operated from a single DC voltage from 12 to 30 V.

1.2.1 Servo-Control

Position feedback is the most effective way to suppress hysteresis and creeping effects. The E-610.C0 includes excitation and readout electronics for capacitive position sensors, with which the piezo translators can be controlled to sub-nanometer resolution. E-610 versions for use with strain and inductive sensors are also available and are described in a separate manual.

The analog input signal (control signal) can either drive the power amplifier input directly, or be fed through a slew-rate limiter and notch filter and/or a position servo-control circuit. The maximum output voltage ranges from -20 to +120 V so as to support the full extension capability of PI low-voltage translators.

1.2.2 Applications

E-610 modules can be used for static and dynamic applications. High output stability and low noise assures stable micropositioning. Because LVPZT translators have high capacitances, the amplifiers are designed to supply appropriate high peak currents for dynamic applications. Excellent linearity and stability allows the use of E-610 modules in precision measurement and control systems.

Small size and compact design combined with excellent specifications make the E-610 series controller a preferred module for OEM users.

Although the modules were designed to drive PZT positioning elements, they can also be used to drive other systems which require controlled operating voltages.

1.23 Computer Control

Computer control of an E-610 can be realized using a DAC-board in a PC to generate the analog input signal. PI offers a driver set for NI LabVIEW which can be used with certain D/A boards. This driver set is compatible with the PI General Command Set (GCS) driver set for use with NI LabVIEW available for all newer controllers from PI. The Analog Controller Driver for use with NI LabVIEW (E-500.ACD) is free of charge, but requires the NI LabVIEW environment from National Instruments for operation. The PI Analog Controller supports all D/A converter boards from National Instruments that are compatible with DAQmx8.3. NI LabVIEW compatibility is given from version 7.1 upwards. Instructions for downloading the Analog Controller drivers is given in a Technical Note.

1.3 Safety Precautions

DANGER

Read This Before Operation:

E-610 modules are OEM amplifiers generating HIGH VOLTAGES for driving LVPZTs. The output power may cause serious injuries.

When working with these devices or using PZT products from other manufacturers we strongly advise you to follow the General Accident Prevention Regulations.

All work done with and on the modules described here requires adequate knowledge and training in handling High Voltages.

Be sure to connect pin 32a/c to a Protective Ground!



CAUTION: Electrostatic Hazard

Electronic components are sensitive to electrostatic electricity. Take appropriate electrostatic protection measures when removing modules.



CAUTION: Equipment Damage

Most piezo stages that can be connected to this controller can be damaged or destroyed by uncontrolled oscillation



near the mechanical resonant frequency. If you observe resonance while configuring your system, switch off power to the actuators concerned immediately and check the settings and servo-control parameters.

2 Description

2.1 Main Module

E-610.C0 controllers are designed as EURO board plug-in modules which can be installed in a desktop chassis as well as in a 19"-rack-mount chassis. They feature sensor excitation and processing for capacitive sensors including demodulator, various filters and ILS.

2.2 Included Connector

Included with the E-610.C0 module is a connector matching the main connector of the module. This socket is designed for installation completely inside the user housing. If the controlled piezo actuator is outside the user housing, the E-610.C0 should be installed so as to make the front panel sensor and PZT drive-voltage sockets accessible. Inserting additional connectors in the sensor lines would require special care to avoid excessive noise introduction, and such connectors are not usually provided.



Fig. 1: Included DIN 41612D connector mates with Eurocard main connector

See “32-Pin Main Connector”, p. 28 for pinouts

3 Operating Modes

E-610.C0 units can be operated as simple power amplifiers, i.e. in voltage-controlled mode, where the PZT output voltage depends directly on the input control voltage and DC offset. This is also known as open-loop or servo-off operation.

They can also be operated in position-controlled (closed-loop) mode. In position-controlled mode, the control input plus DC offset is interpreted as a target *position*, and the signal from the position sensor is used as input to a servo-control feedback loop. Position-controlled mode permits elimination of drift and hysteresis.

In both open- and closed-loop modes, the units can be operated manually or via an external analog control input voltage, or by a combination of the two.

3.1 Manual Offset Operation

In manual operation, the target voltage or position is controlled manually with an external 10 k Ω DC-offset potentiometer (not included). This potentiometer must be connected to pins 12a (-10 V), 14a (GND), and the wiper to pin 12c, and it must be activated by placing jumper X4 toward the front panel. The factory default for X4 is toward the rear (see Section 6.3.2).

3.2 External Operation

For external operation, the offset potentiometer should be deactivated (jumper X4 toward rear, default, see Section 6.3.2), and the target voltage or position is controlled by an external DC signal of -2 to 12 V. Excursions below 0 V and above 10 V should be of minimal duration to assure maximum piezo life. See “Computer Control,” p. 5 for information on PI support of external operation with a DAC card in a PC.

3.3 External Operation with DC Offset

For external operation with offset, the offset potentiometer (or equivalent) must be activated (jumper X4, see Section 6.3.2) and attached and an external DC signal applied to Control IN. The position of the potentiometer (wiper voltage) is added to the analog control input signal. The result must be in the -2 to +12 V range (Excursions below 0 V and above 10 V should be of minimal duration, to assure maximum piezo life). With, for

example, an offset setting of 5 V, the control input could range from -7 to +7 V.

3.4 Open-Loop (Voltage-Controlled) Operation

In open-loop mode, there is no position servo-control^{*}. In this mode, the PZT drive voltage is proportional to the control signal input, in combination with the DC offset potentiometer, if installed and activated. (The sensor electronics works independently and outputs the current piezo position on “sensor monitor” even though that value is not used internally in open-loop mode, provided a sensor is connected). The PZT output voltage can be monitored either directly (in parallel with the PZT) or on main connector pin 8a, which carries a high-impedance output of 1/100th the voltage of the PZT.

The analog input is on pin 10c. With DC offset at zero, the nominal input voltage range is 0 to +10 V for a 0 to 100 V output voltage range. For some applications, where the full expansion capability of the piezo translators is needed, the full output voltage range of -20 to +120 V can be used. The corresponding input voltage range is then -2 to +12 V.

If the input signal available is bipolar, adjust the external DC-offset potentiometer (or an equivalent divider) to the appropriate setting. When set, for example, to provide a 50 V output with 0 V input, a Control input in the -5 to +5 V range will cover the full nominal output range 0 to 100 V.

3.5 Closed-Loop (Position-Controlled) Operation

E-610.C0s have position-sensor processing electronics for closed-loop operation. Closed-loop operation differs from open-loop operation in that the analog control input (plus any DC offset) is interpreted as a target position rather than a target voltage.

Closed-loop operation offers both drift-free and hysteresis-free positioning. The servo-control electronics is implemented on a plug-in submodule, the E-802. See the E-802 User Manual for details.*

^{*} The entire E-802 Servo-Control submodule, including notch filter and slew-rate limiter, can be bypassed with Jumper X3 (see Section 6.3.2), or the servo-control section on the E-802 can be switched off electrically with jumper S101 or by shorting main connector pins 28a and 20a. In this case (with E-802.55s) the slew-rate limiter and notch filter remain active.

In position-controlled mode, it is the output of the P-I (proportional integrated) controller that is used as input to the amplifier. The piezo position is refined until the final position is reached. In this controlled mode, the PZT position is directly proportional to the module's input signal while the PZT supply voltage may not be.

The operating voltage for the PZT must remain in the range from -20 to +120 V. If one of these limits is reached and the resulting expansion of the PZT does not match that specified by the control signal, a TTL signal (overflow) is output on pin 26a.

PI's standard calibration procedure assures that the PZT reaches its nominal expansion value when the control input signal is +10 V.

To enable closed-loop mode perform both of the following steps:

1. Set jumper X3 to the "use-E-802" position, i.e. toward the rear of the module (default)
2. Provide the Servo-ON signal to the E-802 by EITHER connecting rear connector pins 28a and 20a OR closing jumper S101

The notch filter and slew-rate limiter are also active. (Disabling servo mode will not always deactivate them. See the E-802 User Manual for details.)

4 Installation and Operation

4.1 General Instructions

DANGER

Read This Before Operation:

E-610 modules are OEM amplifiers generating HIGH VOLTAGES for driving LVPZTs. The output power may cause serious injuries.

When working with these devices or using PZT products from other manufacturers we strongly advise you to follow the General Accident Prevention Regulations.

All work done with and on the modules described here requires adequate knowledge and training in handling High Voltages.

Be sure to connect pin 32a/c to a Protective Ground!



On the main board of the E-610 modules a DC-DC converter is installed with a 12 to 30 VDC input voltage range. The converter generates -25 and +125 V for the power amplifier and +/-15 V for the sensor and servo-controller.



NOTE

- When powering up the module, the DC-DC converter needs a peak current of about 1.5 A to start oscillating. The power supply should have a buffer capacitor, or the external power supply should be able to supply the 1.5 A for at least 1 second.
- The inputs and outputs of the DC-DC converter are not connected internally. Using an unipolar power supply, we recommend connecting the negative supply at pin 18a,c with the Test GND at pin 20a,c. This provides a defined GND level and helps to minimize noise.

NOTE: Calibration

If your unit is delivered with the PZT actuator that it is to drive, it will have been configured and calibrated with that actuator at the factory. Be careful not to interchange actuators and controllers if you have more than one. It should not be necessary to recalibrate the system unless hardware changes are made. It may be necessary to adjust the zero point if operating conditions such as load or temperature change greatly. For details see section “E-610 Calibration” beginning on page 14.

4.2 System Setup

First decide on an initial operating mode—either voltage-controlled (open-loop, see Section 3.4) or position-controlled (closed-loop, Section 3.5), and set the system jumpers and switches to the corresponding positions (see Section 6.3). Note that with E-802.55 model servo-control submodules, the notch filter and slew rate limiter stay on in open-loop, unless the submodule is bypassed (jumper X3). See the E-802 User Manual for details.

If multiple E-610s are to be operated as part of the same system, it will probably be necessary to synchronize the sensor excitation clocks to avoid interference. This is done by setting the master/slave jumpers (JP1) to “slave” (position 2-3) on all units except one, and connecting the synchronization line (pin 30c, main connector) of all units together.

Connect the actuator and sensor to the front panel connectors. For best accuracy, never interchange the target (yellow) and probe (blue) sensor connectors. Also connect the control input signal and, if any, connect the offset potentiometer (activated by jumper X4). Connect any monitoring instruments you want to use. See Section 4.3 if you will be using the Sensor Monitor signal.



CAUTION: Equipment Damage

Most piezo stages that can be connected to this controller can be damaged or destroyed by uncontrolled oscillation near the mechanical resonant frequency. If you observe resonance while configuring your system, switch off power to the actuators concerned immediately and check the settings and servo-control parameters.

Insert the module in the main connector and power up the system.

With 0 DC offset and servo-control ON, an analog input signal of +10 V should cause the PZT to expand to its nominal value. At zero input, the sensor monitor voltage at main connector 22a (also on JP 202) should also measure zero. If not, perform the Electrical Zero-Point Calibration described on p. 15. At the nominal PZT expansion, pin 22a should measure around +10 V.

Most dynamic applications require the power amplifier to deliver a short peak current higher than the average value. Because of the limited power of the transistors, this peak is limited to about 5 ms in length. After this time the current decreases to the average value.

There may be cases where the control signal calls for an even higher peak current, but the required current cannot be supplied. To avoid such non-linearities, a slew rate limitation is added to the control circuit. This feature guarantees wide signal bandwidth without overdriving the power amplifier.

There are additional potentiometers for optimizing closed-loop operation. See the “E-610 Calibration” Section for details.

4.3 User Electronics and Sensor Monitor Signal

If you are connecting your own electronics to the sensor monitor signal (on main connector, p. 28 and JP 202), make sure it has sufficient input capacitance to eliminate high-frequency interference.

It may be necessary to add a 4.7 nF (ceramic NP0 or COC type) to the input connector. Use shielded cable if possible, otherwise make sure the lead pair is tightly twisted.

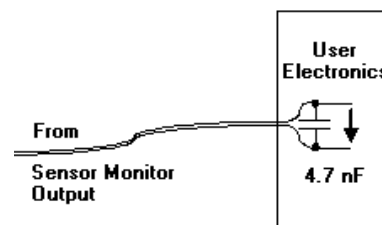

Fig. 2: Electronics on Sensor Monitor line with required input capacitance

5 E-610 Calibration

NOTE

If your unit is delivered with the PZT actuator that it is to drive, it will have been configured and calibrated with that actuator at the factory. Be careful not to interchange actuators and controllers if you have more than one. It should not be necessary to recalibrate the system unless hardware changes are made. It may be necessary to adjust the zero point if operating conditions such as load or temperature change greatly.

All piezo positioning systems with a PZT translator are delivered with performance test documents to verify the system performance. The servo controller is calibrated prior to shipment in our labs. Normally there is no need for the customer to perform a full calibration. Only if the PZT, the sensor, extension cable or the mechanical setup is changed, may new calibration be necessary.

The system is ready for operation upon delivery. PZTs and their assigned controllers are matched and should be considered as a unit. The serial numbers of the PZTs installed are marked on the individual modules.

Some calibration steps, however, must be performed in any case, either to compensate different loading and mounting details or to tune dynamic behavior for stable operation.

NOTE

For some calibration steps the cover plate has to be removed to make certain test points or components on the add-on PCB accessible.

5.1 Equipment Needed for Calibration

Zero-point adjustment requires a voltmeter. Static displacement calibration requires an external expansion gauge with appropriate resolution (e.g. 0.01 μm for a P-841.30 actuator) and a precision voltmeter. Access to adjustment elements on the submodules while the system is in operation is necessary, so an extension connector may be required.

5.2 Preparations

Mount the PZT actuator in the same way and with the same load as during normal operations in the application. In multi-axis systems, make sure the PZTs are always connected to the same controller modules.

5.3 Mechanical Zero-Point Adjustment

Capacitive sensors have a mechanical zero point adjustment. The mechanical zero point adjustment procedure is discussed in the Capacitive Sensor User Manual.

5.4 Electrical Zero-Point Calibration

Electrical zero-point calibration has the goal of making the point of zero expansion coincide with the point of zero control input voltage.

There might be some small deviation of the electrical zero-point caused by thermal drift or changes in mechanical loading. Let the system warm up for several minutes before setting the zero point.

If the electrical zero point is adjusted properly, the full output voltage range of the amplifier can be used and only a small offset is required to get a zero reading. This prevents overflow conditions from arising due to improper match of actual and desired expansion windows.

The adjustment procedure is as follows (see Section 6.3 for location of adjustment elements):

- 1 Before powering up the system, make sure the PZT actuator is mounted in the same way and with the same load as during normal operations in the application
- 2 Make sure the control input is 0 V.
- 3 If there is a DC-Offset potentiometer installed and activated, make sure it is in the 0 V position (usually full counterclockwise), or deactivate it.
- 4 Turn on the +15 V and GND to the E-610 module. Note that for starting the module, a current of at least

1500 mA is required; otherwise the internal oscillator will not start. Only 400 mA are required after start up.

- 5 If you use your own capacitive sensors, adjust the sensor mechanical zero position. For details see Section 5.3 on page 15.
- 6 Set the module to voltage-controlled (servo OFF, open-loop) by opening jumper S101 AND making sure that pin 28a is not connected to ground
- 7 Adjust the offset by tuning potentiometer TR102 (zero adjust) on the module main board, accessible from the front panel.
- 8 Now exercise the PZT over the nominal expansion range by applying analog signals 0-10 V to pin 10c. Then set the PZT to 0 with 0 V at 10c.
- 9 Read the voltage at pin 22a or JP 202 (sensor monitor). Use the zero potentiometer to adjust the reading to zero. The zero point is now close enough to allow going into servo mode.
- 10 Set the unit to servo ON.
- 11 Again using the zero potentiometer, adjust until the PZT monitor out (main connector or JP 202) or the PZT voltage itself is 0 V. Because servo-control is now active, the sensor monitor signal will not change: the servo-controller will move the PZT and hence the sensor until its output is again zero.

5.5 Second-Order Polynomial Linearization

The capacitive sensor electronics includes a trim pot (ILS) for minimizing second-order polynomial non-linearity. To adjust the ILS proceed as follows (see “Main Board and E-802.55 Submodule” on p. 21 for location of the ILS adjustment):

- 1 Before powering up the system, make sure the PZT actuator is mounted in the same way and with the same load as during normal operations in the application. In multi-axis systems, make sure the PZTs are always connected to the same controller modules.
- 2 Mount an external gauge to measure the PZT displacement. Only if the external measurement system offers higher precision than the capacitive sensor the maximum performance can be achieved.

With PZT power amplifier powered down, the external gauge should read 0; if it does not, note the offset and subtract it from subsequent readings.

- 3 Scan the control input voltage at from 0 V to +10 V and read the PZT displacement using an external gauge.
- 4 Adjust the Integrated Linearization System (ILS) by turning the ILS potentiometer TR103 and observe the linearity of the PZT displacement.

5.6 Static Gain Adjustment

It should only be necessary to readjust the static gain if system components have been interchanged or altered. Before doing so, reading the detailed description of the sensor-processing system is recommended (Capacitive Sensor User Manual).

The objective of static gain adjustment is to ensure that the PZT actuator expands to its nominal expansion when a control signal input of 10 V is applied (DC-offset set to 0 or disabled by jumper X4 rear)

The zero-point must be appropriately set before the static gain adjustment can be performed. This is an iterative process.

The static gain adjustment procedure is as follows (location of adjustment elements on the E-802 submodule is described in the E-802 Servo Submodule User Manual; location of mainboard elements in Section 6.3):

- 1 Before powering up the system, make sure the PZT actuator is mounted in the same way and with the same load as during normal operations in the application.
- 2 Mount an external gauge to measure the PZT displacement. (with PZT power amplifier powered down, the external gauge should read 0; if it does not, note the offset and subtract it from subsequent readings)
- 3 Set servo mode to SERVO OFF
- 4 Make sure the DC-Offset potentiometer (if installed and activated) is still set to zero, or deactivate it
- 5 Set control input to 0 V.

- 6 Connect +15 V and GND to the E-610 module.

NOTE

For starting the module, a current of at least 1500 mA is required; otherwise the internal oscillator will not start. Only 400 mA are required after start up.

- 7 Scan the control input voltage from 0 V to +10 V and read the PZT displacement using the external gauge. With +10 V the external gauge should show the PZT at about nominal expansion. Adjust with the sensor gain trim potentiometer TR101 (see Fig. 4). Sensor gain is now close enough to allow switching servo ON.
- 8 Set servo ON.
- 9 Adjust the sensor monitor signal to exactly 10.000 V using the gain adjustment potentiometer on the E-802 servo submodule (different versions of this submodule exist, see the E-802 User Manual for gain adjustment on your unit).
- 10 Adjust the PZT position to the nominal expansion value using the sensor gain adjustment. Now, because servo ON, the sensor monitor value will not change!
- 11 Repeat the last two steps until you get stable readings.

If the gain settings have been changed, the zero-point adjustment starting with section 5.4 should be repeated, and then the static gain rechecked.

5.7 Dynamic Calibration

Dynamic performance of the PZT system is determined by the maximum output current of the amplifier and by the mechanical properties of the PZT mechanics, like moving mass, damping and resonant frequencies. Dynamic calibration optimizes step response and suppresses resonance, overshoot, and oscillation. These servo-loop, notch filter and slew-rate limitation setting procedures are all described in detail in the E-802 Servo-Control Submodule User Manual.

6 Electronics

The basic circuit design of the amplifier and controller modules is shown in the drawings on the following pages. Input signals at main connector pin 10c and the signal from the external DC-offset potentiometer are combined in the preamplifier stage. Depending on the model/configuration, the resultant signal will be used either as input for the amplifier or as input signal for the position servo-control circuit.

6.1 Block Diagram

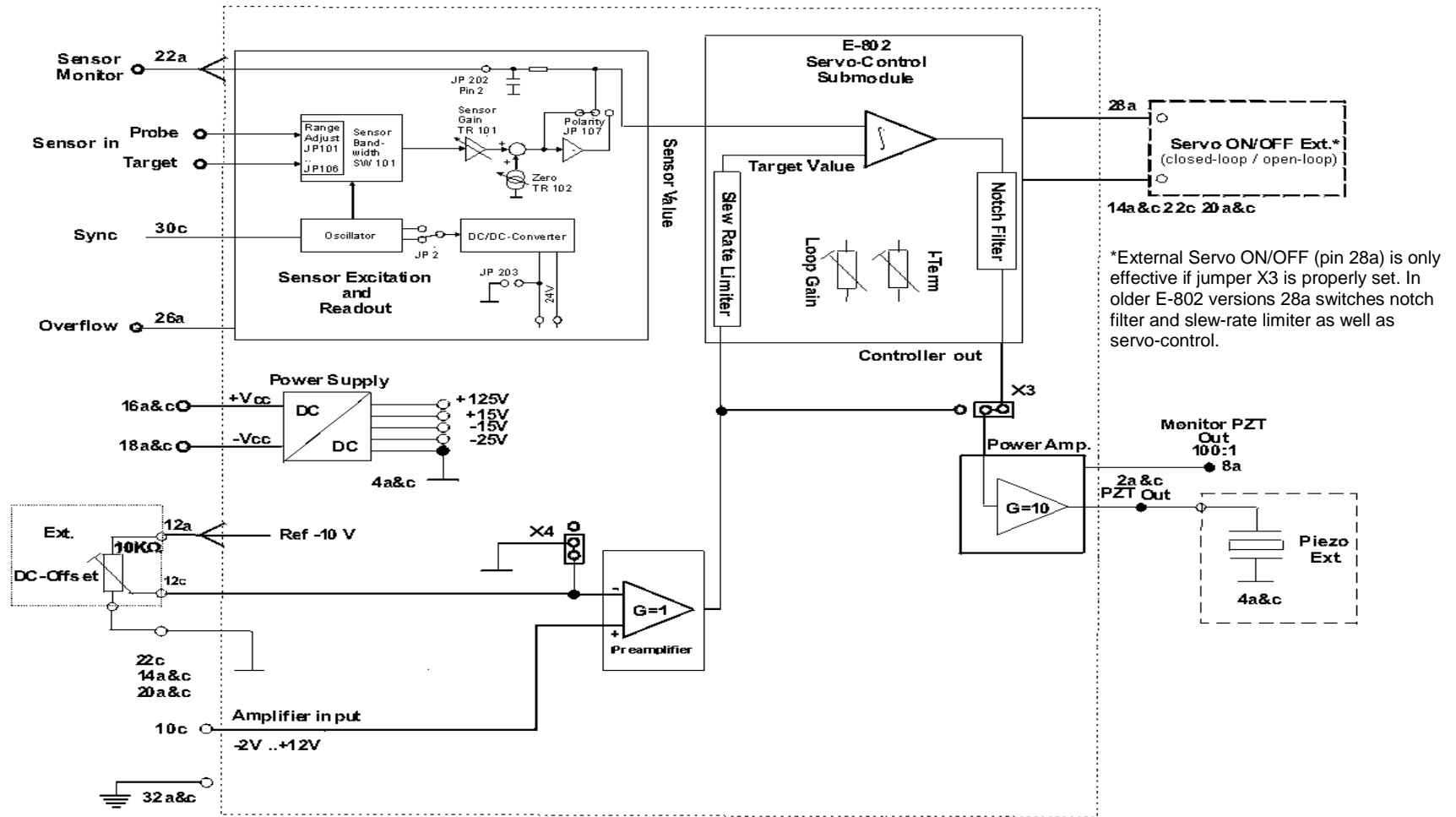

Fig. 3: E-610.C0 block diagram

6.2 Front Panel Indicators

The green LED indicates that the module is powered up and in operation. The amber LED lights when an overflow condition occurs: i.e. an attempt to drive the PZT voltage under -20 or over +120 V.

6.3 Adjustment Elements and Connectors

6.3.1 Main Board and E-802.55 Submodule

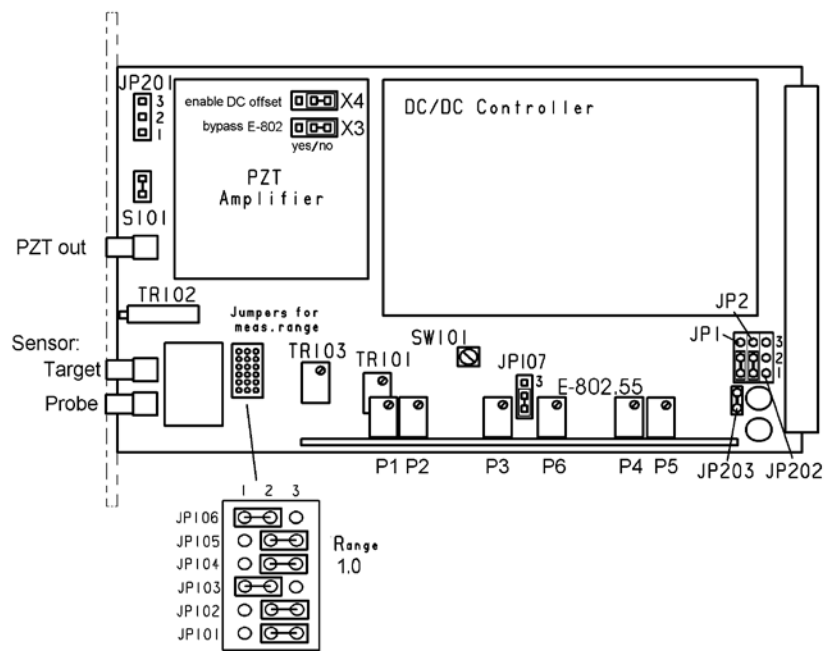

Fig. 4: E-610.CO component layout, “top” view (through cover plate)

Main Board

JP107: Sensor polarity: 1-2 (default) positive (increasing gap results in increasing voltage at Sensor Monitor);
2-3 negative

JP202: 3-pin header connector with signals also on main connector:



Pins	Function
1	PZT monitor
2	Sensor monitor
3	GND

JP203: Jumper: Connects internal -Vcc to GND. If open, bipolar operation enabled.
Default: closed.





JP201: 3-pin connector for external offset potentiometer
Pin 2: wiper; for increasing displacement with clockwise motion, connect Pin 1 to pot CCW side, Pin 3 to pot CW side.

TR101: Sensor: Gain
TR102: Sensor: Zero adjust
TR103: ILS (2nd-order linearization)

SW101: 3-position switch
for sensor bandwidth:

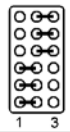
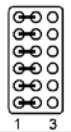
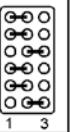
-  Position 1: 300 Hz
-  Position 2: 3000 Hz
-  Position 3: 1500 Hz

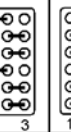
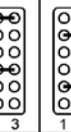
JP101 to JP106: Sensor Measurement Range

Measurement range extension factor	No measurement	0.56	0.68	0.75	1.0	1.25	2.13	3.0
Jumper Positions	JP106 JP105 JP104 JP103 JP102 JP101							
		1 3	1 3	1 3	1 3	1 3	1 3	1 3

The jumper group is shown as arranged on the main board (see component map, Fig. 4). Units are delivered set as required for the attached stage. With no information on the stage, PI sets units to 1.0.

JP1: 1-2: Internal Synchron. (master, default)
2-3: External Synchronization (slave)

JP2: 1-2: DC/DC converter clock 200 kHz default
2-3: DC/DC converter clock 100 kHz, should not be used

S101: Jumper not installed: open-loop
Installed: closed-loop (default)

E-802.55 Servo-Control Submodule

P1:	Slew rate of control input
P2:	Gain of servo loop
P3:	Integral term of servo loop
P4:	Notch filter frequency
P5:	Drift compensation

6.32 PZT Amplifier Section Jumpers

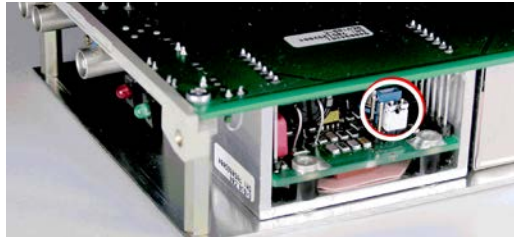

Fig. 5: Bottom view of PZT Amplifier section with jumpers (circled, color may differ) X3 (inner, here blue) and X4 (outer, here white) shown in default positions (toward rear of module)

The PZT Amplifier section is on small PCB soldered to the main board. It carries the two barely accessible 3-pin jumpers X3 and X4 (see Fig. 5) which can be positioned either toward the front panel or toward the main connector at the rear (default).

Jumper X4 (closest to the edge of the board) controls activation of the DC-offset potentiometer. Deactivating the pot when none is attached may reduce noise imperceptibly.

X4 (outer jumper) Toward rear: DC offset potentiometer deactivated (default)
Toward front panel: DC offset pot activated

The inner jumper, X3 (more difficult to access) controls bypassing the E-802 Servo-Control Submodule.

X3 (inner jumper) Toward rear: Use E-802 (default)
Toward front panel: Bypass E-802 (servo-control not possible, notch filter & slew rate limiting also off)

6.4 Servo-Control Electronics

Servo-control is implemented in a plug-in submodule, the E-802. It should not be necessary to remove or replace the submodule, but if you ever do so, note the submodule component side direction, as shown in Fig. 4.

The E-802 submodule processes the control signal for the amplifier driving the piezoelectric translators. Slew rate limitation, notch filter and servo-control loop are all implemented on the E-802.

The servo-control section of the E-802.55 can be switched off by an electrical signal (jumper S101 opened AND main connector pin 28a not connected to ground), but notch filter and slew rate limiting remain active. The E-802 can be completely bypassed by placing the inner jumper of the PZT amplifier section in the “front” position (see p. 23).

The servo-loop logic compares the control voltage input (target) and the sensor signal (actual position) to generate the amplifier control signal using an analog proportional-integral (P-I) algorithm.

For calibration procedures, see Section 5 and the E-802 Servo-Control Submodule User Manual.

7 Technical Data

7.1 Specifications

Channels:	Single-channel
Output voltage range:	-20 to +120 V
Peak output current:	140 mA (5 ms max.)
Max. average output current:	60 mA
Max. average output power:	6 W (with forced-air cooling > 10 m ³ /h)
Control input voltage range:	-2 to 12 V, shiftable with DC offset
Voltage gain:	10+/-1%
Input impedance:	> 100 kΩ
DC-offset adjustment range:	100 volts wide: adds 0 to +10 V to Control In
Bandwidth:	See frequency response curves (Figure below)
Ripple of Uout:	20 mVpp at low frequencies 40 mVpp (spikes) at 30 kHz
Piezo output connector (on front panel):	Lemo EPK.00.
Main connector:	DIN 41612 D Eurocard connector
Sensor input connectors (on front panel):	2x LEMO EPL 00, 2-conductor; target and probe individually shielded
Front panel LED	Green: power on Red: overflow: (attempt to drive PZT out > 120 V or < -20 V)
Sensor monitor output:	0 to +10 V for nominal expansion
Overflow signal:	(Pin 26a) TTL active-high for control voltage < -2V or > +12V
Max. Power consumption:	15 W
Operating voltage range:	12 to 30 VDC, max. ripple 50 mV pp (15 V recommended)
Operating current:	2 A max.
Dimensions:	EURO-board: 160 x 100 x 35.6 mm

7.2 Frequency Response

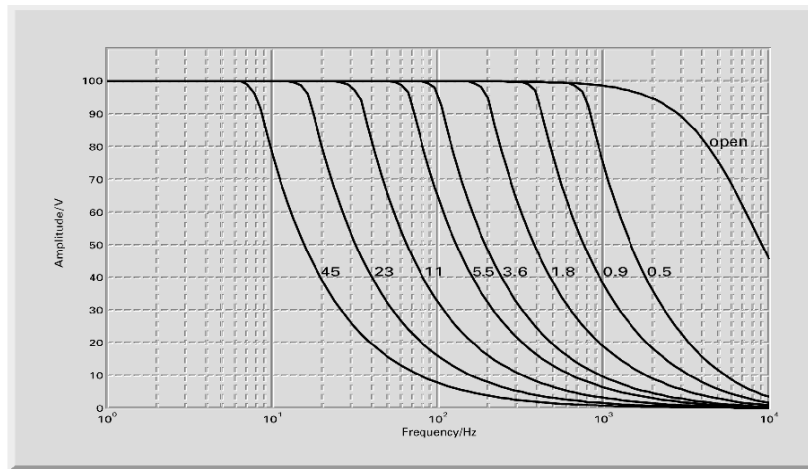

Fig. 6: E-610 open-loop frequency response with various PZT loads. Values shown are capacitance in μF , measured in actual PZT.

7.3 Dimensions

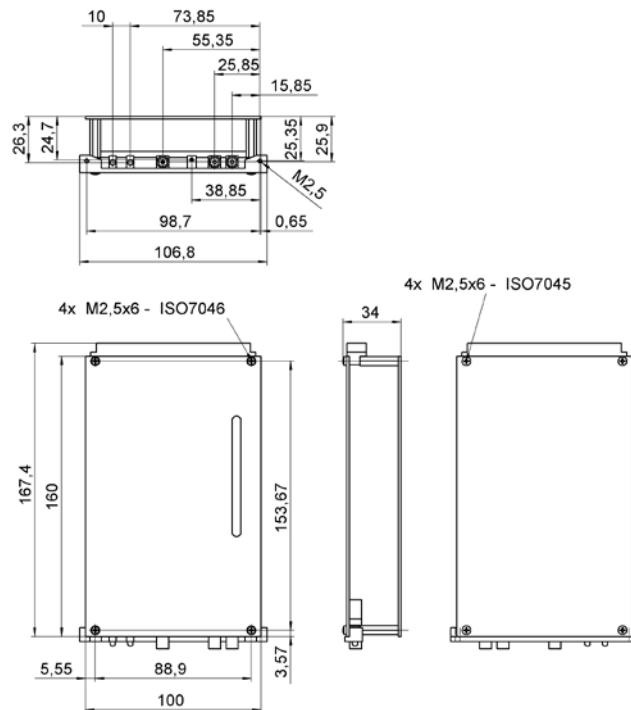

Fig. 7: E-610.C0 dimensions in millimeters

8 Pin Assignments

8.1 System Connection Summary

For operation, at least the following elements must be connected:

	Main Connector	Front Panel	Only for
Supply power, 12-30 VDC	+ 16a&c; - 18a&c		
PZT out	2 a&c		
PZT GND	4a&c		
Sensor probe in		Lemo connector	closed-loop
Sensor target in		Lemo connector	closed-loop
Control in	10c		*
DC-offset pot	12a 12c & 14ac		*
GND	20a&c, 14a&c		
Protective GND	32a&c		
Sync in or out	30c		multi-axis

*The DC-offset pot may be missing (deactivate with X4) or the Control In signal shorted, but not both.

8.2 32-Pin Main Connector

Because the DIN 41612 connector standard includes types with more pins, the 32 pins of the “D” version all carry even-number designations and are in rows “a” and “c” only.

PZT output	a	2	c	PZT output
PZT GND	a	4	c	PZT GND
nc	a	6	c	nc
Monitor PZT out (100:1)*	a	8	c	internal use
Internal use	a	10	c	Amplifier input
10 kOhm pot (-10V)	a	12	c	Pot wiper
10 kOhm pot (GND) & test GND	a	14	c	Pot 10 kOhm (GND) & test GND
+VCC supply	a	16	c	+VCC supply
-VCC supply	a	18	c	-VCC supply (connect to 20c for minimum noise) ¹
Test GND	a	20	c	Test GND
Sensor monitor*	a	22	c	Sensor monitor GND, Test GND*
nc	a	24	c	nc
Overflow (TTL)	a	26	c	nc
Servo OFF/ON select	a	28	c	Internal use
Internal use	a	30	c	Cap sensor excitation external clock sync.
Protective GND	a	32	c	Protective GND

* Sensor Monitor and PZT Monitor are also available on JP 202.

8.3 Sensor Connectors

E-610.C0 modules have two 2-pin LEMO sockets on the front panel for the sensor connection. Because of the high accuracy of capacitive sensors (and hence their sensitivity to noise) these lines are not duplicated on the main connector. Probe and target lines are individually shielded. Do not interchange the probe and target connectors.

See the Capacitive Sensor User Manual for more information on capacitive sensors.

¹ Internally grounded by jumper JP203 as default

9 Appendix: Piezoelectric Positioning Topics

9.1 Low-Voltage Piezoelectric Translators (LVPZT)

Low-voltage piezoelectric translators are micropositioning elements operated within a nominal voltage range from 0 to +100 V. Expansion values given in PI main catalog are based on this nominal voltage range.

Due to the excellent manufacturing quality including sophisticated insulation techniques, LVPZ translators made by *Physik Instrumente* can be used beyond their nominal operating voltage range. The maximal allowed voltage range covers -20 to +120 V.

This extended operating range gives 40% more expansion than the nominal values. LVPZTs specified with 40 μm nominal expansion can thus be used with a range of 56 μm . Positive voltages cause the PZT to expand, negative voltages cause it to contract. The maximum test voltage in the positive direction is 150 VDC.

Applying negative voltages to the LVPZT cause an electrical field opposed to the polarization direction. The PZT contracts. Depolarization can occur if the negative voltage exceeds -40 V.

Although in many cases the LVPZT can be repolarized by applying an electric field in the “right” direction, we recommend not exceeding the allowed operating voltage range. *Physik Instrumente* will refuse any warranty claim after over-voltage operation.

The negative voltage with maximum allowable magnitude is -20 V. If you are working with original *Physik Instrumente* electronics, the LVPZTs always will be driven in their safe operating area and cannot be damaged, (LVPZT stages, however, may sustain other damage if driven at their mechanical resonant frequency).

9.2 Sensors for Low-Voltage PZT Translators

Low-voltage piezoelectric translators are available with integrated position sensors. Most of the piezo-driven stages and tip/tilt mirror systems are also equipped with internal

sensors.

Three main classes of sensors are used: strain gauge sensors (SGS), linear variable differential transformers (LVDT) and capacitive sensors.

The E-610.C0 is for use with capacitive sensors only. These sensors provide the highest degree of accuracy. See the Capacitive Sensor User Manual for more information.

10 EC Declaration of Conformity

For the E-610 Low-Voltage Piezo Amplifier/ Controller Module, an EC Declaration of Conformity has been issued in accordance with the following EMC standards and normative documents:

Low Voltage Directive
EMC Directive
RoHS Directive

The applied standards certifying the conformity are listed below.

Safety (Low Voltage Directive): EN 61010-1:2010

EMC: EN 61326-1:2013

RoHS: EN 50581:2012

